

Article number: 20240628450E

Description: E+G Telescope-Lear motion bearings GN 2406-28-450-E

Measures

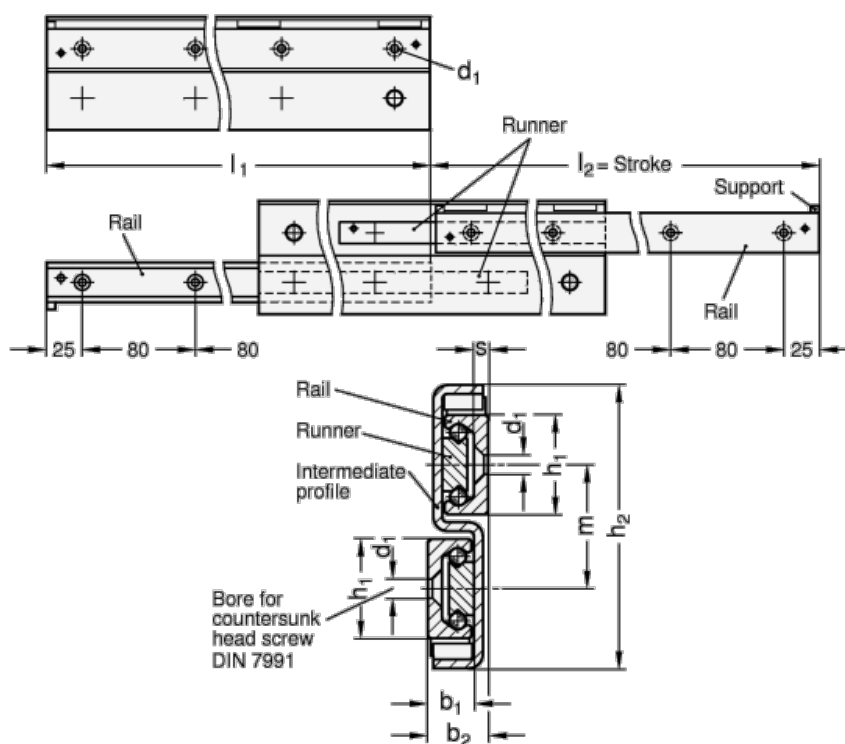

$b_1 = 12.3$

$b_2 = 17$

$d_1 = 5.5$

$h_1 = 28$

$h_2 = 80$

$L_1 = 450 - 464$

$m = 35$

$s = 4$

Weight in (g) = 2930